



PRICE LIST

FIRE EXTINGUISHING PANELS AND DEVICES

(All prices in INR. Prices do not include applicable taxes)



Ceasefire Industries Pvt. Ltd.

www.ceasefire.in



CONTENTS

FIRE EXTINGUISHING PANELS AND DEVICES

Intelli-Sense Addressable Control Panels

02

Intelli-Sense Field Devices

07

Wave Sense Field Devices

12

Pro-Sense Conventional Control Panels

13

Pro-Sense Field Devices

15

Rapid Sense Control Panels And Field Devices

17

CEASEFIRE X PLUS ADDRESSABLE FIRE ALARM SYSTEMS



The revolutionary Ceasefire X Plus Addressable Fire Alarm Systems are the best in class detection and alarm system to safeguard the fire safety of a large premises.

As the name suggests, these systems are addressable systems i.e. each detector & device is connected on an addressable loop.

Identity of each of the device is stored as a unique address in the panel.

In case of a fire incidence the panel identifies and displays the exact location of the device that gone-off.

This enables the fire fighter to track down the precise point of fire incidence so that there is no delay in fire fighting.

This systems is an ideal fire detection & alarm system for large premises that spread over a vast area.

An intelligent fire alarm system that comes with an easy user interface and flexible configurations to suits varied type of applications.

Price: ₹1,18,200



Code: TI-002317-V

Name/ Description: Intelli-Sense - 1 Loop Panel Fire Alarm Control Panel

Price: ₹1,36,200



Code: TI-002318-V

Name/ Description: Intelli-Sense - 1-2 Loop Panel Fire Alarm Control Panel

Price: ₹2,44,500



Code: TI-002219-V

Name/ Description: Intelli-Sense - 1-4 Loop Panel Fire Alarm Control Panel

Price: ₹5,20,500



Code: TI-002320-ST

Name/ Description: Intelli-Sense - 2-8 Loop Panel Fire Alarm Control Panel - Standard

Price: ₹5,96,400



Code: TI-002320-FT

Name/ Description: Intelli-Sense - 2-8 Loop Panel Fire Alarm Control Panel - Fault Tolerant

Price: ₹1,14,000



Code: TI-002321-ST

Name/ Description: Remote Control Terminal - Standard

Price: ₹1,51,800



Code: TI-002321-FT

Name/ Description: Remote Control Terminal - Fault Tolerant

Price: ₹81,900



Code: TI-002322-ST

Name/ Description: Remote Display Terminal - Standard

Price: ₹1,35,000



Code: TI-002322-FT

Name/ Description: Remote Display Terminal - Fault Tolerant

Price: ₹1,23,300



Code: TI-002323-ST

Name/ Description: Large Remote Display Terminal - Standard

Price: ₹1,71,000



Code: TI-002323-FT

Name/ Description: Large Remote Display Terminal - Fault Tolerant

Price: ₹45,900



Code: TI-002324

Name/ Description: Intelli-Sense - Fault-Tolerant Network Card

Price: ₹23,100



Code: TI-002325

Name/ Description: Intelli-Sense - Standard Network Card

Price: ₹21,900

Code: TI-002326

Name/ Description: Loop Driver Card

Price: ₹2,90,400



Code: TI-002327

Name/ Description: TouchControl Terminal - Standard

Price: ₹3,72,300



Code: TI-002328

Name/ Description: TouchControl Terminal - Fault Tolerant

Price: ₹11,100

Code: TI-002329

Name/ Description: Surface Back-Box for TouchControl Terminal

Price: ₹48,000

Code: TI-002330

Name/ Description: BMS/Graphics Interface Card (Standard Network) - PCB Only

Price: ₹67,200

Code: TI-002330-BX

Name/ Description: BMS/Graphics Interface Card (Standard Network) - Boxed

Price: ₹81,900

Code: TI-002331

Name/ Description: BMS/Graphics Interface Card (Fault-Tolerant Network) - PCB Only

Price: ₹98,400

Code: TI-002331-BX

Name/ Description: BMS/Graphics Interface Card (Fault-Tolerant Network) - Boxed

Price: ₹88,800



Code: TI-002332

Name/ Description: ipGateway Card (Standard Network) - PCB Only

Price: ₹1,07,100



Code: TI-002332-BX

Name/ Description: ipGateway Card (Standard Network) - Boxed

Price: ₹1,70,400



Code: TI-002333

Name/ Description: ipGateway Card (Fault-Tolerant Network) - PCB Only

Price: ₹1,89,000



Code: TI-002333-BX

Name/ Description: ipGateway Card ((Fault-Tolerant Network) - Boxed

Price: ₹3,23,100



Code: TI-002334

Name/ Description: Commander BMS Interface Module

Price: ₹4,10,400



Code: TI-002335

Name/ Description: Commander BMS Interface Module - Configured

Price: ₹4,71,900

Code: TI-002336

Name/ Description: Graphic Control Software (Standard Version) - Up to 3 Network Nodes

Price: ₹6,35,400

Code: TI-002337

Name/ Description: Graphic Control Software (Standard Version) - Up to 15 Network Nodes

Price: ₹11,15,400

Code: TI-002338

Name/ Description: Graphic Control Software (Premium Version) - Up to 15 Network Nodes

Price: ₹10,16,400

Code: TI-002339

Name/ Description: Graphic Control Software (Standard Version) - Up to 200 Network Nodes

Price: ₹17,10,600

Code: TI-002340

Name/ Description: Graphic Control Software (Premium Version) - Up to 200 Network Nodes

Price: ₹3780



Code: TI-002211

Name/ Description: Intelligent Optical Smoke Detector With Isolator

Price: ₹3630



Code: TI-002212

Name/ Description: Intelligent Optical Smoke Detector Without Isolator

Price: ₹3930



Code: TI-002213

Name/ Description: Intelligent Multi Criteria Detector With Isolator

Price: ₹3720



Code: TI-002214

Name/ Description: Intelligent Multi Criteria Detector Without Isolator

Price: ₹3600



Code: TI-002215

Name/ Description: Intelligent Class-P Heat Detector With Isolator

Price: ₹3420



Code: TI-002216

Name/ Description: Intelligent Class-P Heat Detector Without Isolator

Price: ₹12,540



Code: 002217

Name/ Description: Intelligent Multiway 4 Input & 4 Relay Output Module

Price: ₹12,540



Code: 002218

Name/ Description: Intelligent Multiway 4 Input, 2 Relay Output, and 2 Supervised Output Module

Price: ₹5820



Code: 002219

Name/ Description: Intelligent Single Supervised Output Module

Price: ₹5820



Code: TI-002220

Name/ Description: Intelligent Relay Output Module

Price: ₹5340



Code: TI-002221

Name/ Description: Intelligent Input Module

Price: ₹6600



Code: TI-002222

Name/ Description: Intelligent Input & Output Module

Price: ₹6600



Code: TI-002223

Name/ Description: Intelligent Input & Relay Output Module

Price: ₹9420



Code: TI-002224

Name/ Description: Conventional Zone Module

Price: ₹2370



Code: TI-002225

Name/ Description: Isolator Module

Price: ₹5340



Code: TI-002226

Name/ Description: Intelligent Manual Call Point

Price: ₹5340



Code: TI-002431

Name/ Description: Intelligent Manual Call Point (New Variant)

Price: ₹8700



Code: TI-002227

Name/ Description: Weatherproof Manual Call Point Housing (Red)

Price: ₹17580



Code: TI-002229

Name/ Description: Duct Detector Housing

Price: ₹7050

Code: TI-002230

Name/ Description: Duct Detector Housing - Air Sampling Tube

Price: ₹330



Code: TI-002231

Name/ Description: Intelligent Detector Base

Price: ₹6840



Code: TI-002232

Name/ Description: Intelligent Addressable Base Sounder

Price: ₹10,470



Code: TI-002233

Name/ Description: Intelligent Addressable Base Sounder With Visual Indicator

Price: ₹5340



Code: TI-002295

Name/ Description: Intelligent Input Module (Mini Mount)

Price: ₹5820



Code: TI-002296

Name/ Description: Intelligent Single Supervised Output Module (Mini Mount)

Price: ₹5820



Code: TI-002297

Name/ Description: Intelligent Relay Output Module (Mini Mount)

Price: ₹6450



Code: TI-002298

Name/ Description: Intelligent Input & Output Module (Mini Mount)

Price: ₹6450

Code: TI-002299

Name/ Description: Intelligent Input & Relay Output Module (Mini Mount)

Price: ₹4020

Code: TI-002260

Name/ Description: Intelligent Sounder Interface Module

Price: ₹8490

Code: TI-002260 + TI-002272

Name/ Description: Intelligent Addressable Wall Sounder

Price: ₹11970

Code: TI-002260 + TI-002273

Name/ Description: Intelligent Addressable Wall Sounder With Visual Indicator

Price: ₹14,760



Code: TI-002277

Name/ Description: Wireless Optical Smoke Detector

Price: ₹15,390



Code: TI-002278

Name/ Description: Wireless Multi-Criteria (Optical and Thermal) Detector

Price: ₹14,430



Code: TI-002279

Name/ Description: Wireless Class P Heat Detector

Price: ₹17,250



Code: TI-002257

Name/ Description: Wireless Manual Call Point

Price: ₹17,250



Code: TI-002347

Name/ Description: Wireless Manual Call Point (New Variant)

Price: ₹12,540



Code: TI-002253

Name/ Description: Wireless Single Channel Input Module

Price: ₹25,080



Code: TI-002255

Name/ Description: Single Channel Output Module

Price: ₹19,860



Code: TI-002256 + TI-002272

Name/ Description: Wireless Sounder

Price: ₹23,340



Code: TI-002256 + TI-002273

Name/ Description: Wireless Sounder

Price: ₹21,960



Code: TI-002258

Name/ Description:
Wireless Sounder Base

Price: ₹26,670



Code: TI-002259

Name/ Description: Wireless Sounder Cum Strobe Base

Price: ₹18,810



Code: TI-002280

Name/ Description: Wireless Translator Module

Price: ₹18,810



Code: TI-002282

Name/ Description: Wireless Expander Module

Price: ₹18,810



Code: TI-002283

Name/ Description: Wireless Conventional Interface Module

Price: ₹15,390



Code: TI-002256

Name/ Description: Wireless Sounder Interface Module

CEASEFIRE X PLUS PRO-SENSE : CONVENTIONAL FIRE ALARM SYSTEM



PRO-SENSE
Conventional Control Panel

The Ceasefire X Plus Pro-Sense Conventional Fire Alarm System is a time-tested and one of the most reliable systems for ensuring fire safety of a premises.

This system divides the premises into distinct zones. Each zone has its own set of detectors & alarm devices.

These field devices within each zone are wired on a dedicated circuit.

On being triggered, the panel is able to identify the circuit that contains the triggered device/ devices and thereby indicate the zone from where the fire alarm has come from.

The indicated zone can then be manually searched to locate the triggered device.

Pro-Sense is an ideal fire alarm system for small facilities where the expectation from fire alarm solution is to detect fire and raise an alarm.

A technically advanced conventional fire alarm system that is adept at turning a premises into a secured space.

Price: ₹28,200



Code: TI-002306

Name/ Description: 2 Zone Conventional Fire Alarm Control Panel

Price: ₹30,900



Code: TI-002307

Name/ Description: 4 Zone Conventional Fire Alarm Control Panel

Price: ₹54,600



Code: TI-002308

Name/ Description: 8 Zone Conventional Fire Alarm Control Panel

Price: ₹70,800



Code: TI-002309

Name/ Description: 12 Zone Conventional Fire Alarm Control Panel

Price: ₹1,07,100



Code: TI-002310

Name/ Description: 16 Zone Conventional Fire Alarm Control Panel

Price: ₹1,43,400



Code: TI-002311

Name/ Description: 24 Zone Conventional Fire Alarm Control Panel

Price: ₹1,79,700



Code: TI-002312

Name/ Description: 32 Zone Conventional Fire Alarm Control Panel

Price: ₹90,600



Code: TI-002313

Name/ Description: LCD Remote Display Fire Alarm Repeater Panel

Price: ₹51,000



Code: TI-002314

Name/ Description: 12 Way Fully Functional Passive Repeater Panel

Price: ₹1740



Code: TI-002265

Name/ Description: Optical
Smoke Detector

Price: ₹1590



Code: TI-002267

Name/ Description: Class-B
Heat Detector

Price: ₹1590



Code: TI-002268

Name/ Description: Class-A1R
Heat Detector

Price: ₹420



Code: TI-002270

Name/ Description:
Universal Detector Base

Price: ₹2400



Code: TI-002226

Name/ Description:
Manual Call Point

Price: ₹4560



Code: TI-002271

Name/ Description:
Conventional Beacon

Price: ₹4470



Code: TI-002272

Name/ Description:
Conventional Wall Sounder

Price: ₹7950



Code: TI-002273

Name/ Description: Conventional
Wall Sounder With Visual
Indicator

CEASEFIRE X PLUS RAPID SENSE : EXTINGUISHING ALARM SYSTEM



Rapid Sense Extinguishing Panels are more than just alarming solution. These panels are engineered for monitoring, detection, alarm as well as active extinguishing.



Price: ₹69,000



Code: TI-002341

Name/ Description: 3 Zone Automatic Extinguishing Control Panel

Price: ₹7,500



Code: TI-002342

Name/ Description: Manual Abort Switch

Price: ₹7,500



Code: TI-002343

Name/ Description: Manual Release Switch

Price: ₹2700

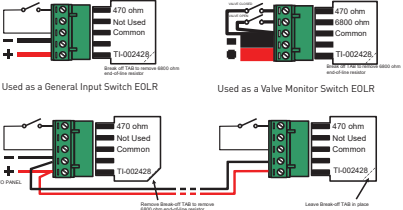

Code: TI-002428

Name/ Description: Switch End-of-Line Module



Download the Ceasefire app.



Ceasefire Industries Private Limited
Plot No. 4, Second Floor, Sector - 135,
Noida - Greater Noida Expressway,
Noida - 201 301, Uttar Pradesh (India)
t +91 120 4665800

Call our Free Hotline :
1800 120 3473 / +91 9540 666 666
or call +91 120 4223473

www.ceasefire.in

Follow us on:

